

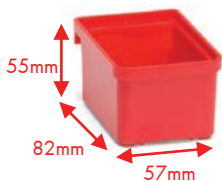

System Boxes and Dividers



System Box

Art. No. 05581 035 001
(Excludes dividers)



System Box

Art. No. 05581 035 002
(Excludes dividers)

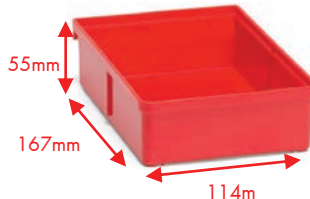

System Box

Art. No. 05581 035 003
(Excludes dividers)

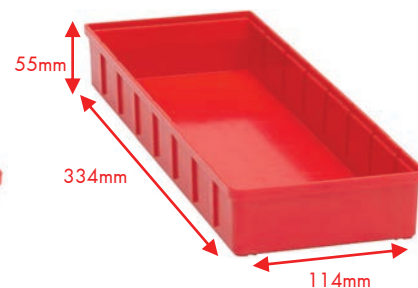

System Box

Art. No. 05581 035 012
(Excludes dividers)

Layout Suggestions:



The above images are purely for suggestion, the ORSY Case 4.4.1 does not include any system boxes or dividers

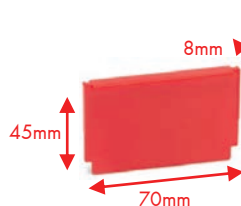

Divider

Art. No. 05581 035 020

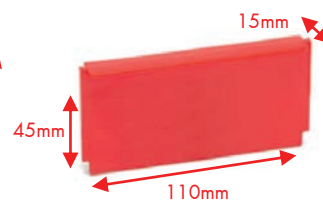

Divider

Art. No. 05581 035 021

ORSY Case



ORSY Case Black - EMPTY

Art. No. 05581 020 000 - Case 4.4.1
Art. No. 05581 010 000 - Case 8.4.1



ORSY Case Transparent - EMPTY

Art. No. 05581 020 500 - Case 4.4.1
Art. No. 05581 010 500 - Case 8.4.1



ORSY Trays and Dividers



3 Compartment Tray - 18 Dividers

Art. No. 05581 003 010
(Excludes dividers)



Dividers for 05581 003 010

Art. No. 05581 003 014



5 Compartment Tray - 30 Dividers

Art. No. 05581 003 011
(Excludes dividers)



Dividers for 05581 003 011

Art. No. 05581 003 015



WALL SHELF 500 - 36 PIECE (SIZE 4)

With universal rail for storage boxes in size 4. Ideal for workshops, trade businesses

- Colour-coded grouping of storage boxes for optimum arrangement of storage space
- Optimised access for assembly areas

Art. No. 00962 200 010

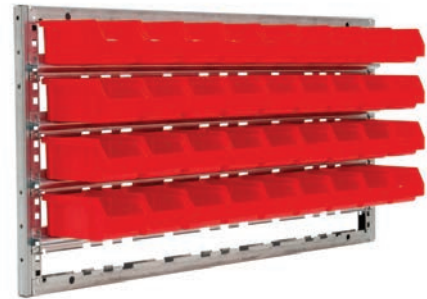

WALL SHELF 1000 - 90 PIECE (SIZE 4)

With universal rail for storage boxes in sizes 3/4. Ideal for workshops, trade businesses and industry for storage of small and/or spare parts.

- Optimal storage space arrangement through colour-coded grouping of storage boxes

Art. No. 00962 200 021



WALL SHELF 1300 - 78 PIECE (SIZE 4,3)

With universal rail for storage boxes in sizes 2/3/4. Ideal for workshops, trade businesses and

- Optimal storage space arrangement through colour-coded grouping of storage boxes

Art. No. 00962 200 030



WALL RAIL ASSEMBLY - FOR INDIVIDUAL WALL MOUNTING OF EASY-VIEW STORAGE BINS

Art. No. 00960 70



Suitable for storage boxes	Size 3
Length	880 mm
Number of boxes	6 PCS
Material	Steel

Art. No. 00960 80



Suitable for storage boxes	Size 4
Length	880 mm
Number of boxes	9 PCS
Material	Steel



For storing small parts, consumables and bulk materials in a way that makes them easy to locate. Ideal for workshops, trade businesses and industry.

- Resistant to common greases and oils
- Temperature-resistant from -20°C to +90°C

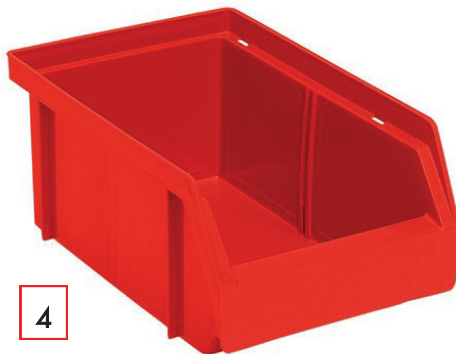
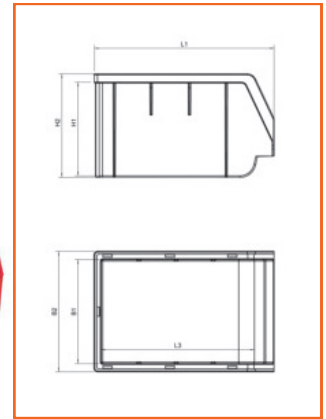

Image	Art. No.	P. Qty.	Size	Size Length (L1)	Width (B2)	Height (H2)	Internal width (B1)	Height (from floor to stacking rim)	Length (internal base) (L3)
1	00962 211 011	1	1	489mm	304mm	185mm	280mm	172mm	425mm
2	00962 211 021	1	2	335mm	209mm	152mm	191mm	139mm	293mm
3	00962 211 031	1	3	230mm	150mm	130mm	130mm	118mm	192mm
4	00962 211 041	1	4	161mm	105mm	75mm	89mm	63mm	137mm
5	00962 211 051	1	5	90mm	102mm	50mm	88mm	44mm	68mm